

ALLIED MAKER

Atelier Pendant 14"

Featuring a hand-spun brass shade perfectly fitted to a cast-glass dome, the Atelier Pendant is a contemporary take on a pendant.



Standard Materials:
Brass, Glass

Shown As:
Flat Black, Opal Globe

Standard Dimensions:
14" L x 14" W x 10.5" H

Glass Finishes:
Matte White, Opal

Metal Finishes:
Available in all
Metal Finishes

Lead Time:
16 weeks

ALLIED MAKER
Array 2 Pendant

Mounting: Universal
Weight: 14.75 lb

Mounting Drawing

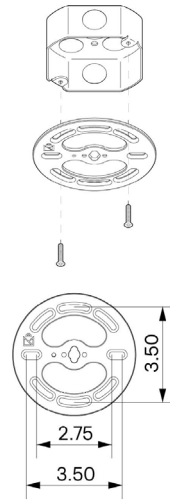

Dimensional Drawing

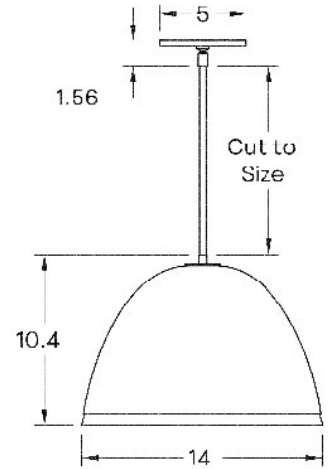

Lamping:

G8 Bi-Pin Base. Type T
Lamps

Lamp Quantity:

4

Bulb Included (120V USA):

Emery Allen 4.5W G8 Bulb

Brightness:

1800 Lumens

Max Wattage:

8W

Bulb Included (240V EU):

Emery Allen 4.5W G8 240V
Bulb

Dimming:

LED+

Certifications:

CE, Damp Locations, Outdoor and Wet
Locations, UL and cUL Certified



ALLIED MAKER

Materials and Finishes

METAL MATERIAL FINISHES

Custom materials & finish matching available.

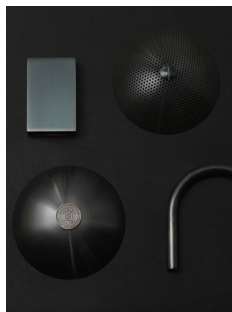

Blackened Brass



Brass

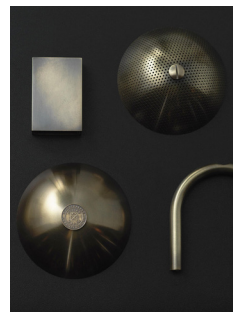

Bronze

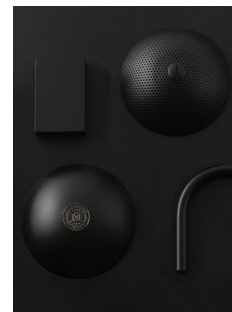

Flat Black



Gradient

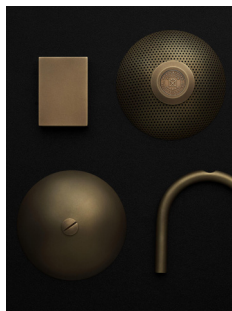

Heritage Brass

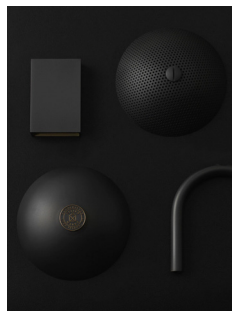

Maker Black

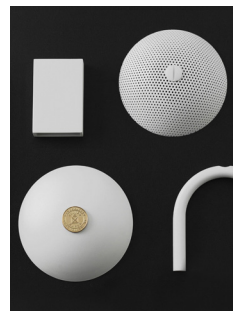

Matte White



Nickel

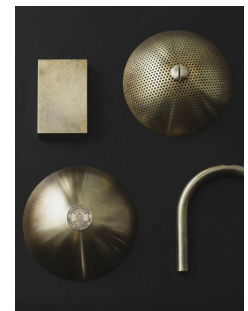

Raw Brass

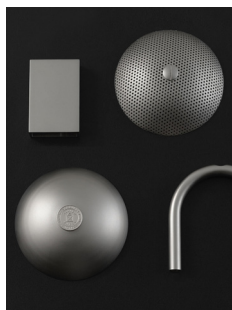

Sandblasted Grey

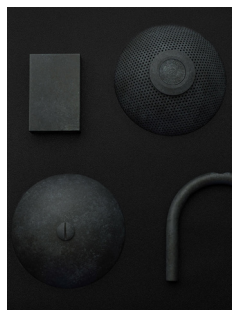

Slate



Verdigris

ALLIED MAKER

Materials and Finishes

GLASS MATERIAL FINISHES

Custom materials & finish matching available.



Matte White Glass



Opal Glass