

CO/ONY

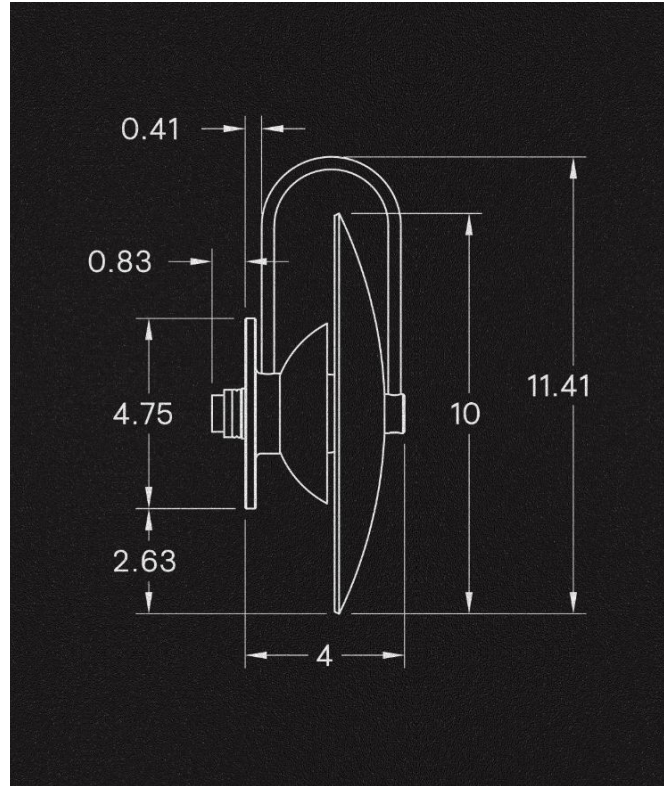

ALLIED MAKER

ADA Aperture Sconce 10"

Standard Materials:

Brass, Glass

Standard Dimensions:

4"L x 10"W x 11.5"H

Lead Time:

Please Inquire

CO/ONY

Dimming :

LED+

Certifications:

ADA Compliant, CE, Damp Locations, UL and cUL Certified

Weight:

3.25 lbs

Metal Finishes

Available in all standard metal finishes

Glass Finishes

Opal, Skytek, Smoked

Lamping:

E12 or E14 Screw Base. Type G16.5 Lamps

Brightness:

500 Lumens

Lamp Quantity:

1

Bulb Included (120V USA):

Feit 5.5 W E12 Bulb

Please inquire for detailed electrical specs.

ETL listed to UL, CE and CSA standards, suitable for damp locations.

CO/ONY

ALLIED MAKER

Materials & Finishes

Custom materials & finishes matching available

STANDARD GLASS FINISHES



Opal Glass



Smoked Glass



Smoked Glass

CO/ONY

ALLIED MAKER

Materials & Finishes

Custom materials & finishes matching available

STANDARD METAL FINISHES

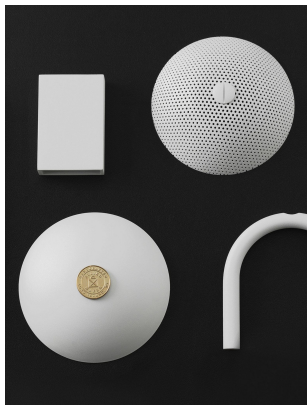

Matte White



Nickel

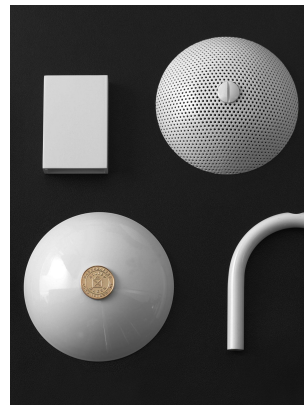

Porcelain White

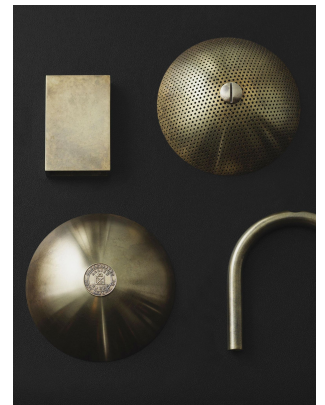

Raw Brass

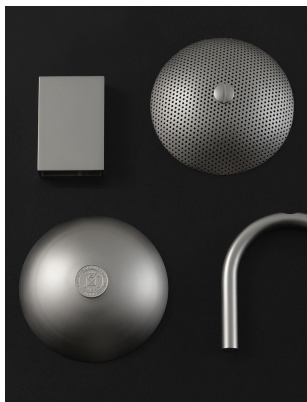

Sandblasted Grey

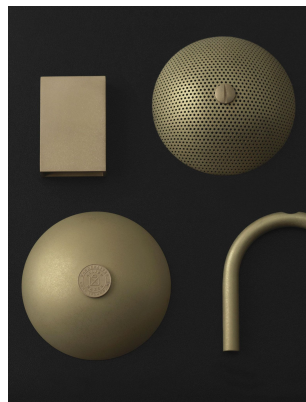

Stonewashed Brass



Verdigris

CO/ONY

ALLIED MAKER

Materials & Finishes

Custom materials & finishes matching available

STANDARD METAL FINISHES

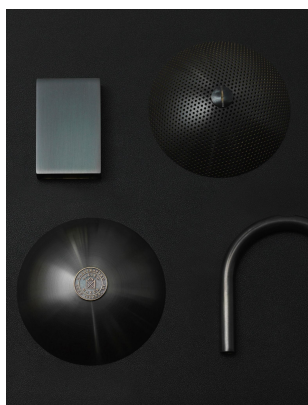

Blackened Brass



Brass

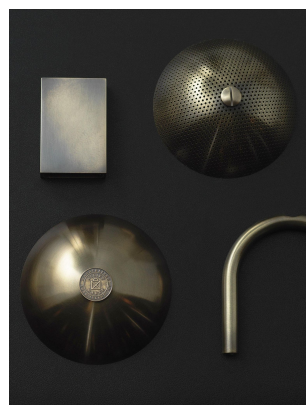

Bronze

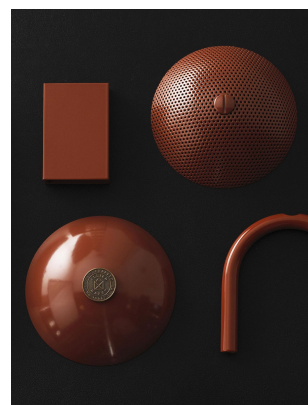

Burnt Sienna

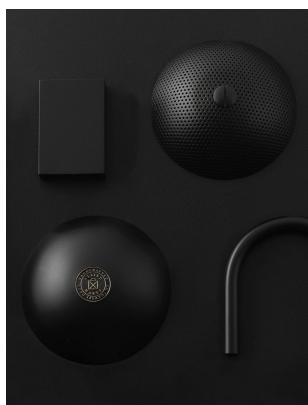

Blackened Brass

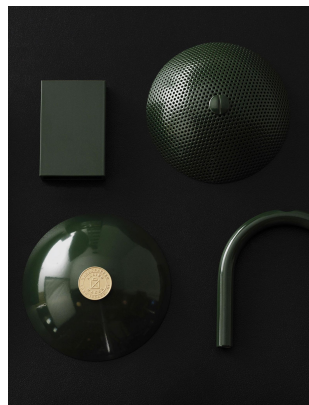

Brass

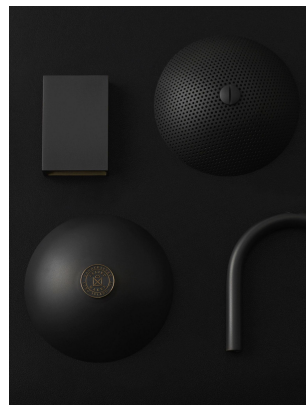

Bronze

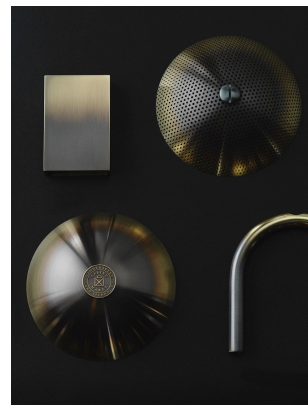

Burnt Sienna