

CO/ONY

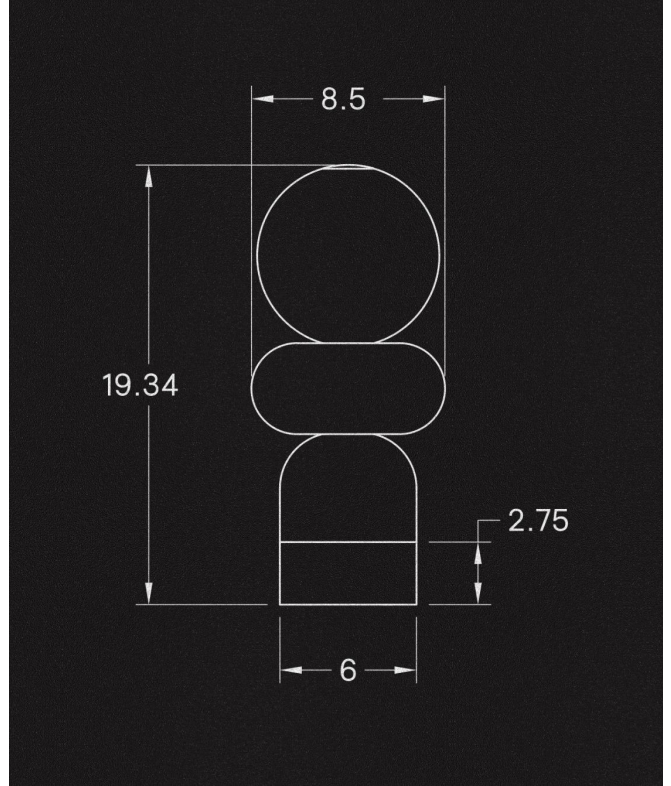

ALLIED MAKER

Alabaster Totem 3 Table Lamp

Standard Materials:

Brass, Wood, Alabaster

Standard Dimensions:

8.5"L x 8.5"W x 19.34"H

Weight:

55.75 lbs

Lead Time:

Please Inquire

CO/ONY

Metal Finishes

Available in all standard metal finishes

Wood Finishes

Available in all standard metal finishes

Dimming :

0-10 V Universal

Certifications:

CE, Damp Locations, UL and cUL Certified

Lamping:

Integrated Low Voltage LED with Driver

Included • 120 V - 277V • 900mA 28 ~ 42 V

Constant Current LED Driver AC DC Converter

Topology 1 Output • 30.7 W Total Output

Brightness:

3700 Lumens

Lamp Quantity:

3

Bulb Included (120V USA):

Philips 9.5W Bulb

Please inquire for detailed electrical specs.

ETL listed to UL, CE and CSA standards, suitable for damp locations.

CO/ONY

ALLIED MAKER

Materials & Finishes

Custom materials & finishes matching available

STANDARD WOOD FINISHES



American Ash

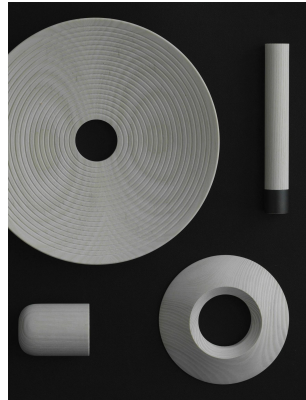

Bleached Ash



Bleached Oak



Bleached Walnut



Blackened Ash

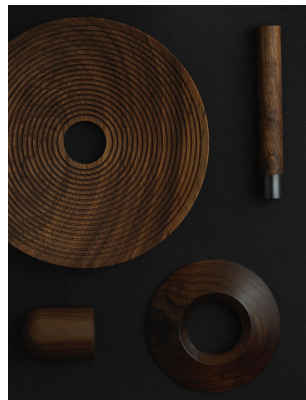

Black Walnut

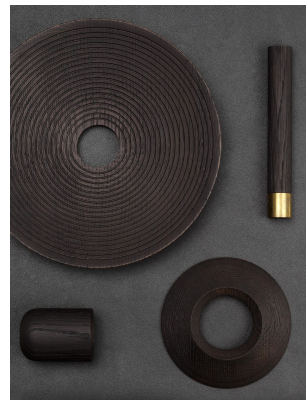

Flame Blackened Oak

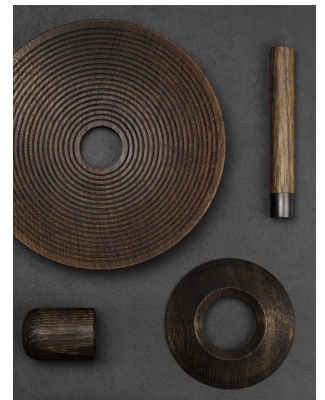

Oxidized Oak



Silver Oak



White Oak

CO/ONY

ALLIED MAKER

Materials & Finishes

Custom materials & finishes matching available

STANDARD METAL FINISHES

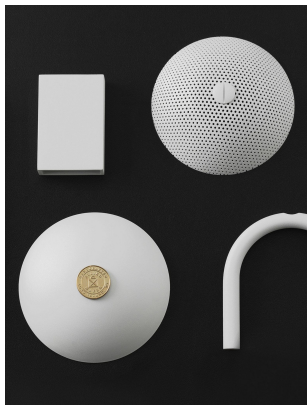

Matte White



Nickel

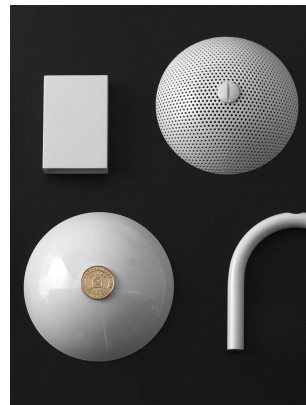

Porcelain White

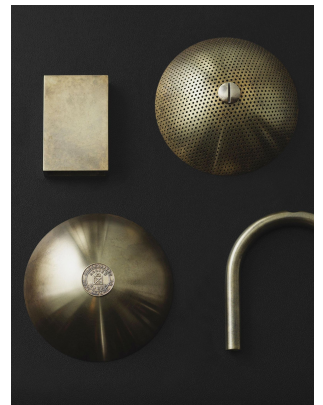

Raw Brass



Sandblasted Grey

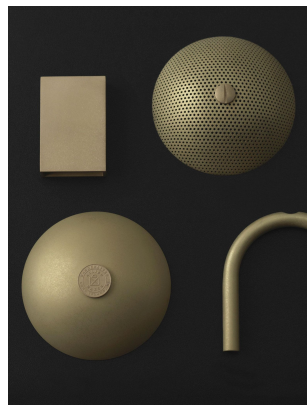

Stonewashed Brass



Verdigris

CO/ONY

ALLIED MAKER

Materials & Finishes

Custom materials & finishes matching available

STANDARD METAL FINISHES

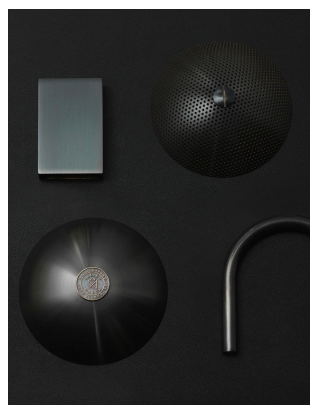

Blackened Brass



Brass

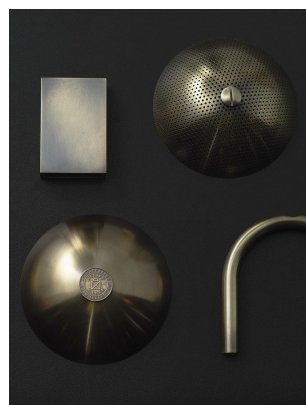

Bronze

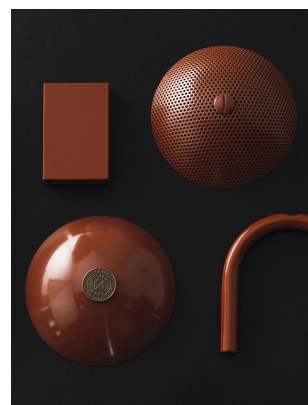

Burnt Sienna

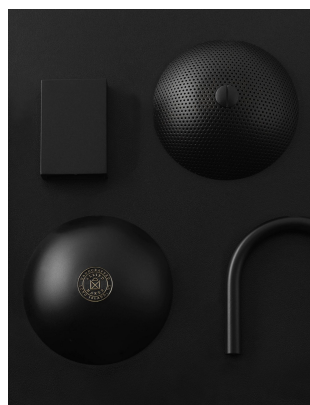

Blackened Brass

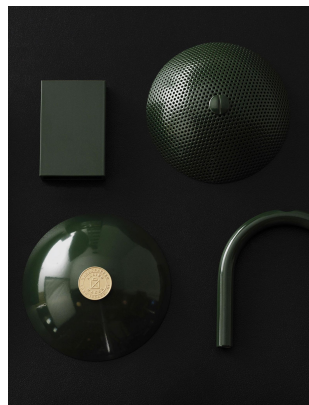

Brass

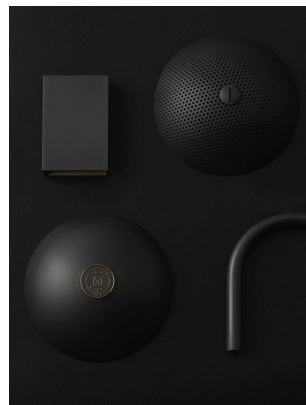

Bronze

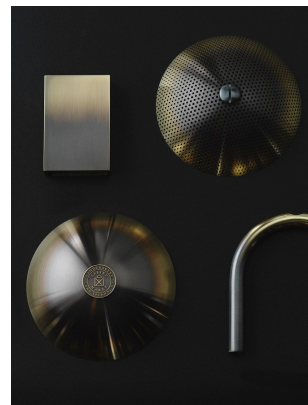

Burnt Sienna