

CO/ONY

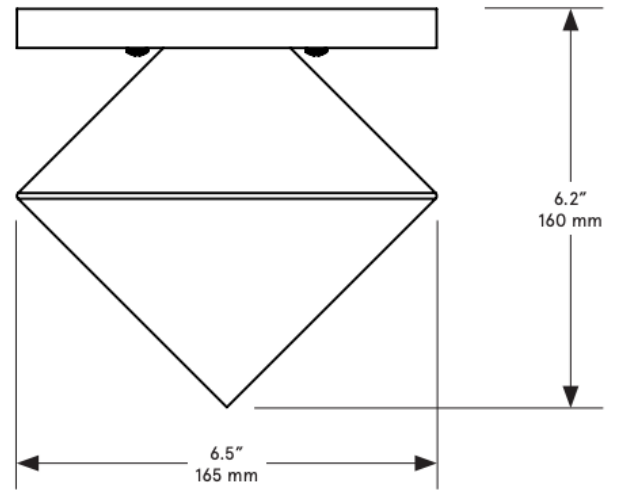

BEC BRITTAIN FKA Themis Surface Mount

Standard Materials: Brass and Glass

Dimensions: 6.5"Ø x 6.2"H

Lead Time: 14-16 weeks

Weight: 2lb

Canopy:

6.5"Ø x .6"D, matching finish

LED Illumination:

G9 LED Bulb
ELV Dimming
110-220 VAC
2.5 Watt
240 Lumens
2700 Kevlin
220-240 VAC
4 Watt
250 Lumens
3000 Kelvin

Electrical:

110-120 VAC
2.5 Watt
240 Lumens
220-240 VAC
4 Watt
250 Lumens

Wiring:

Direct 120/240 VAC line voltage connection.
Requires an Electronic Low-Voltage dimmer switch.

*Please inquire for detailed electrical specs.
ETL listed to UL, CE and CSA standards, suitable
for damp locations.*

CO/ONY

Bec Brittain

Materials & Finishes

Custom materials & finish matching available

STANDARD METAL FINISHES*

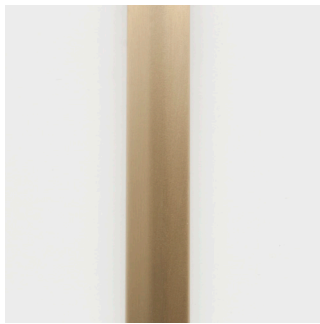

Brushed Brass



Satin Nickel



Oil Rubbed Bronze



Nickel Brass Contrast

SPECIAL FINISHES - 10% UPCHARGE

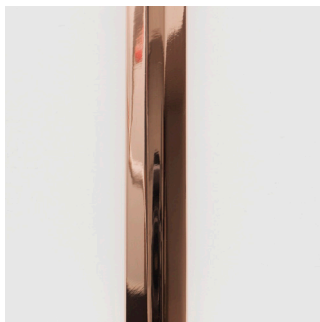

Polished Copper



Medium Antique Brass

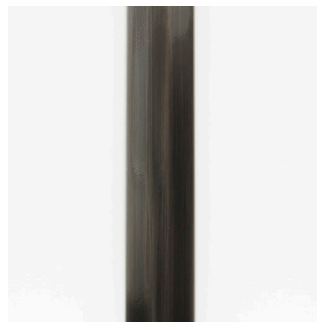

Dark Pewter



Polished Brass

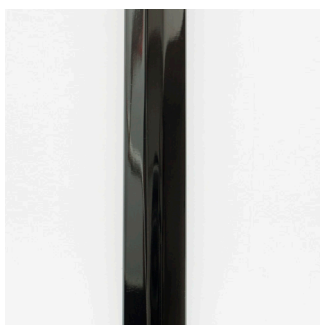

Polished Black Nickel

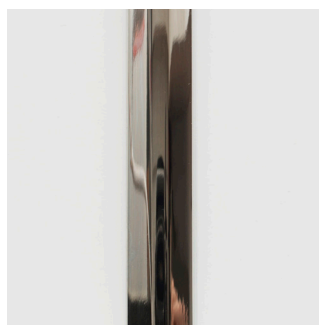

Polished Nickel

CO/ONY

Bec Brittain

Materials & Finishes

Custom materials & finish matching available

THEMIS GLASS

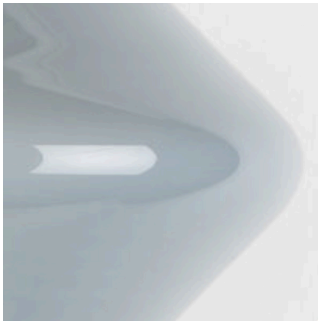

Grey

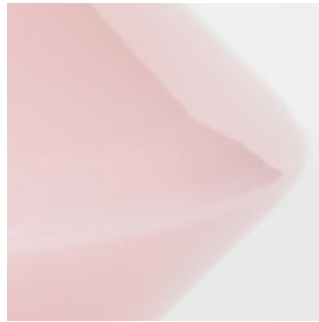

Soft Pink



Ivory



White



Clear

THEMIS MARBLE

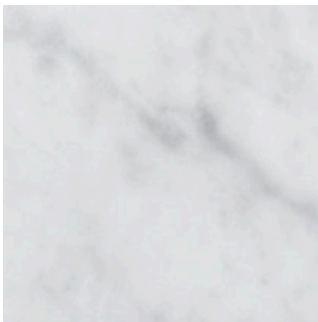

White Marble