

CO/ONY

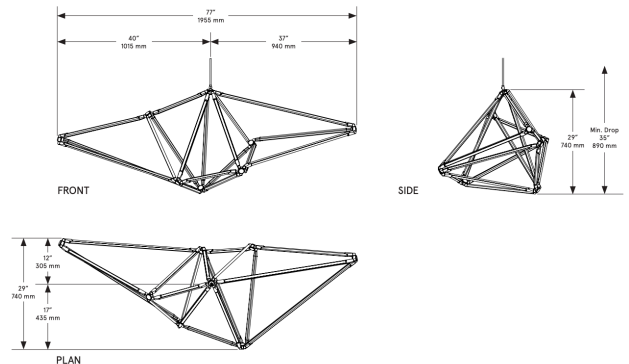

BEC BRITTAIN Shy 01

Standard Materials: Brass
Diffusers available at additional cost

Dimensions: 77"L x 29"W x 29"H

Lead Time: 14-16 weeks

Weight: 31 lb

LED Illumination:

24 VDC T5 LED tube
2700 Kelvin
90 CRI

Electrical:

93 Watt
7440 Lumens
110 - 240 VAC
277 VAC upon request

Standard Installation:

Locally Mounted Driver
0-10V wireless dimming (Lutron Pico)
10.25"Ø x 1.625"D canopy, matching finish

Alternate Installation:

Remotely Mounted Driver
0-10V hardwired dimming
5"Ø x .25"D canopy, matching finish

Suspension:

1/8" IP all-thread stem clad in brass tubing with matching metal finish up to 35" length included with fixture. Length up to 95" available for additional cost.

*Please inquire for detailed electrical specs.
ETL listed to UL, CE and CSA standards, suitable for damp locations.*

CO/ONY

Bec Brittain

Materials & Finishes

Custom materials & finish matching available

STANDARD METAL FINISHES



Brushed Brass

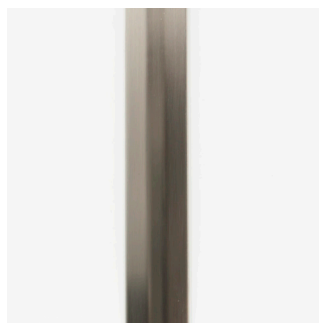

Satin Nickel



Oil Rubbed Bronze



Nickel Brass Contrast

SPECIAL FINISHES - 10% UPCHARGE

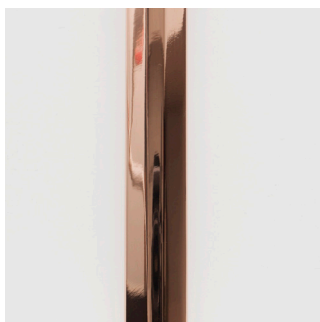

Polished Copper



Medium Antique Brass

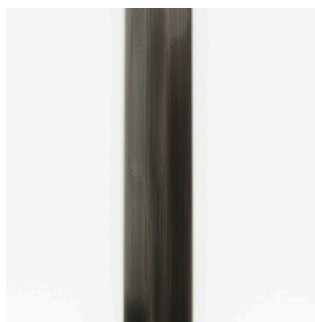

Dark Pewter

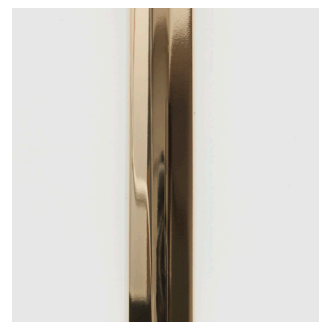

Polished Brass

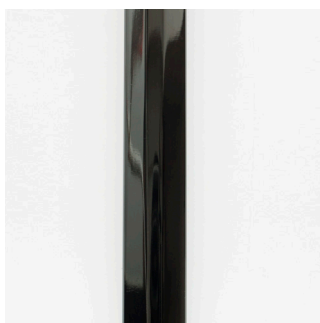

Polished Black Nickel

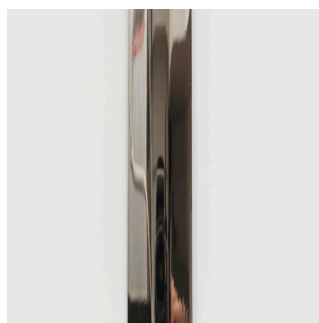

Polished Nickel

CO/ONY

Bec Brittain

Materials & Finishes

Custom materials & finish matching available

SHY DIFFUSER GLASS FINISHES (ADDITIONAL COST)



Iridescent Glass



Two-way Mirror

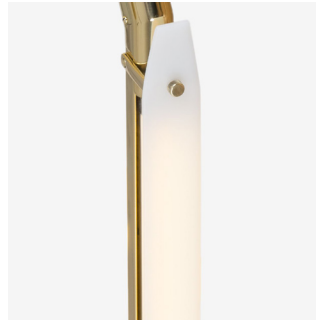

White Sandblast Glass